



# TD-YXH0303

## Junction Box

### Features

- Aluminum alloy material with surface spray treatment
- Camera cables can be perfectly collected to the junction box so that the installation looks more elegant
- Bottom inlet and side inlet
- Available for wall or ceiling mounting
- Water-proof design

### Specifications

Model	TD-YXH0303
Material	Aluminum alloy
Color	White
Min. Packaging Quantity	20
Packing Size	405x330x340mm
Dimension	155.4x50mm
Load Bearing	The wall must be strong enough to withstand at least 3 times the weight of the camera and the junction box
Net Weight	573g
Working Temperature	-40°C~+60°C(-40°F~+140°F)
Working Humidity	10%~90%

### Available Model

Available Model	TD-YXH0303	Junction Box
-----------------	------------	--------------

**Dimensions**

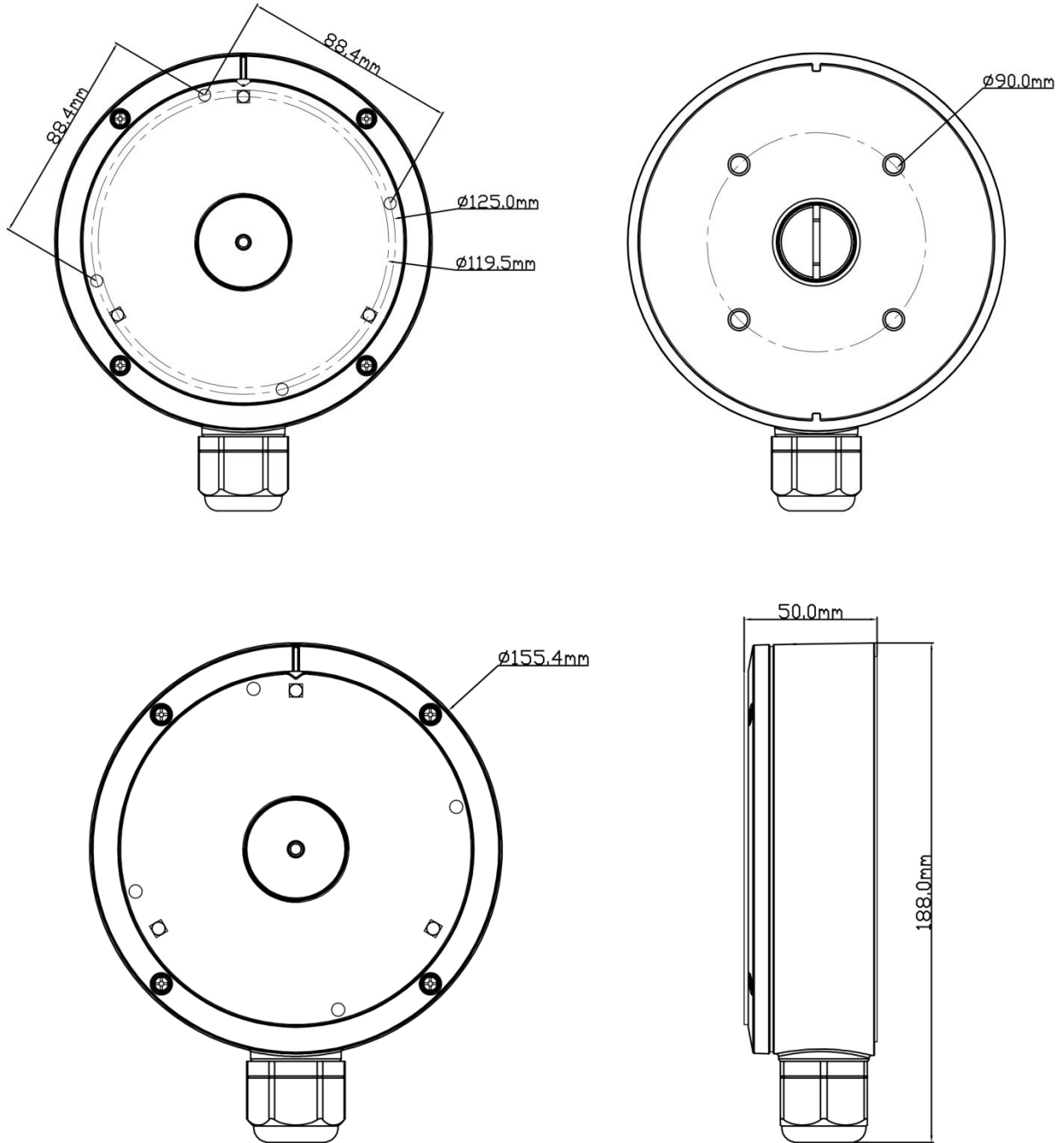

**Shenzhen TVT Digital Technology Co., LTD.**

Address: 23<sup>rd</sup> Floor, Block B4, Building NO.9, Shenzhen Bay Eco-Technology Park, Nanshan District, Shenzhen, Guangdong Province, P.R. China

Tel: +86-755-36995888

Website: <http://en.tvt.net.cn>

Fax: +86-755-33104777

E-mail: [overseas@tvt.net.cn](mailto:overseas@tvt.net.cn)